

MHF[®] 5

Low-profile (mated height = 1.0 mm max.), supports to 12 GHz



- ✓ Small form factor with big performance through 12 GHz
- ✓ MHF[®] 5 Plug available, micro-coax
O.D.(AWG) : 0.81 mm (36), 0.64 mm (36), 0.48 mm (38)
- ✓ Lowest profile connector of MHF[®] series

| | | |
|-------------------------------------|---|--------------|
| Maximum height (mm) | 1.0 | |
| Outside dimension of receptacle(mm) | 2.0 x 2.0 | |
| Applicable wire gauge | O.D. 0.48 mm / AWG 38 O.D. 0.64 mm / AWG 36 O.D. 0.81 mm / AWG 36 | |
| Frequency | DC~12 GHz | |
| VSWR (L=100 mm) | DC~3 GHz | 1.3 max. |
| | 3 GHz~6 GHz | 1.5 max. |
| | 6 GHz~9 GHz | 1.6 max. |
| | 9 GHz~12 GHz | 1.6~1.8 max. |
| | 12 GHz~15 GHz | - |
| Service temp. (Celsius) | -40 degree ~ +90 degree | |
| Characteristic impedance | 50 ohm | |
| Rated voltage | AC60V | |
| Contact resistance | 20m ohm max. | |
| Withstand voltage | AC200V/min | |
| Insulation resistance | 500M ohm min./DC100V | |

Small form factor with big performance through 12 GHz

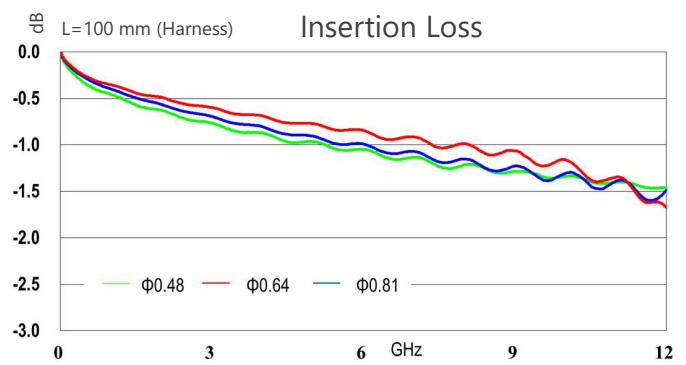
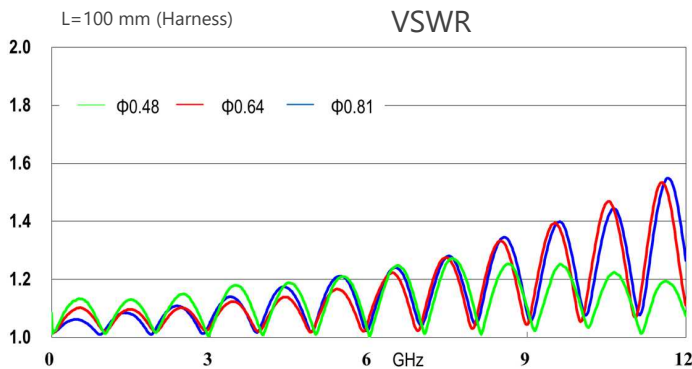

MHF[®] 5 Plug available, micro-coax O.D. (AWG) : 0.81 mm (36), 0.64 mm (36), 0.48 mm (38)

| Coax O.D. (Center Conductor AWG) | Mating Height 1.0 mm max. |
|----------------------------------|---------------------------|
| 2.00 mm (26) | |
| 1.80 mm (30) | |
| 1.37 mm (30) | |
| 1.32 mm (32) | |
| 1.13 mm (32) | |
| 0.95 mm (33) | |
| 0.81 mm (33) | |
| 0.81 mm (36) | ○ |
| 0.64 mm (36) | ○ |
| 0.48 mm (38) | ○ |
| Receptacle | MHF 5 receptacle |

Lowest profile connector of MHF[®] series



MHF[®] 5

Component Parts Detail

MHF[®] 5 plug Au (0.81,0.64)

| Recommended P/N | | 20669-001R-81 |
|-----------------|--------------------|-----------------------|
| PART NO. | APPLICABLE CABLE | OUTER CONDUCTOR |
| 20669-001R-81 | AWG#36 (0.64 O.D.) | SPIRAL SHIELD |
| | AWG#36 (0.81 O.D.) | SINGLE BRAIDED SHIELD |

Offered as harness only.

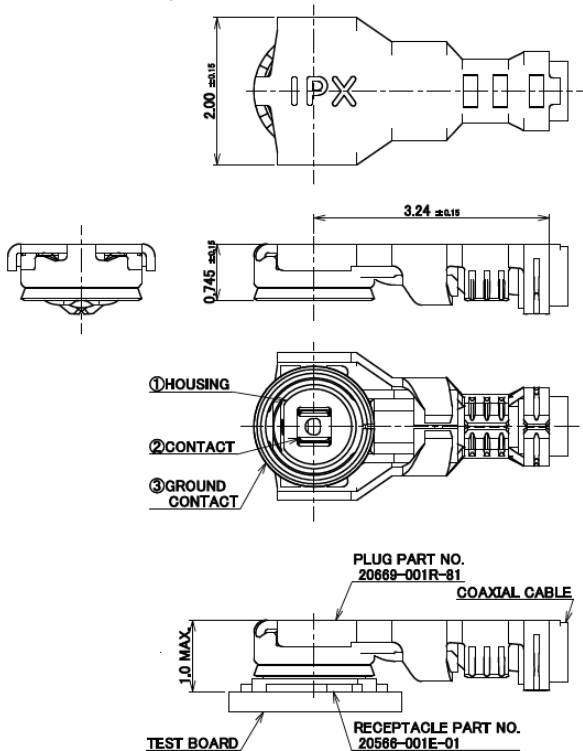
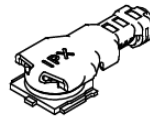

NOTES

1. APPLICABLE CONNECTOR
20566-001E-01
2. PERMISSIBLE LOAD OF CABLE AT MATING
3. MATING AND UNMATING INSTRUCTION
 - 3-1. MATING
MATE THE CONNECTOR VERTICALLY AS MUCH AS POSSIBLE, ADJUSTING THE MATING AXIS OF PLUG AND RECEPTACLE, DO NOT SLANT MATE.
 - 3-2. UNMATING
 - 3-2-1. IN CASE OF UNMATING BY PULLING TOOL (PART NO. 90612-0001)
USE THE PULLING TOOL AS THE FOLLOWING DRAWING, AND PULL PLUG TO VERTICAL DIRECTION AS DIRECTLY AS POSSIBLE.
 - 3-2-2. IN CASE OF UNMATING DIRECTLY BY HAND.
CATCH THE CATCHING AREA OF PLUG, AND PULL PLUG TO VERTICAL DIRECTION AS DIRECTLY AS POSSIBLE.
4. PRECAUTIONS FOR CABLE POSITION
THE PLUG SHALL NOT BE PLACED WITHIN 50 DEGREES ANGLE FROM CENTER OF THE SIGNAL CONTACT. TILT THE PLUG AT LEAST 50 DEGREES FROM THE CENTER OF A SIGNAL CONTACT.

NOTE 2.

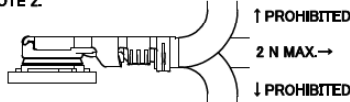

NOTE 3-2-1.

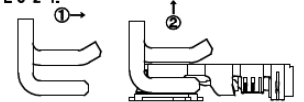

NOTE 3-1.

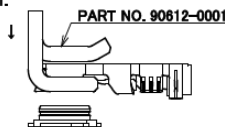

NOTE 3-2-2.

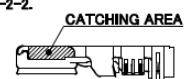

| NO. | DESCRIPTION | MATERIAL | FINISH, REMARKS |
|-----|----------------|-----------------|--|
| 3 | GROUND CONTACT | PHOSPHOR BRONZE | ALL OVER NI 1.00 μm MIN. CONTACT PART Au 0.05 μm MIN. |
| 2 | CONTACT | PHOSPHOR BRONZE | ALL OVER NI 1.00 μm MIN. CONTACT PART Au 0.05 μm MIN. |
| 1 | HOUSING | LCP | UL94V-0, BLACK |

MATING CONDITION

Rev.2

MHF[®] 5 plug Au (0.81,0.64)

| ITEMS | SPECIFICATION |
|---|---|
| RECOMMENDED APPLICABLE CONNECTOR PART No. | 20566-001E-01 |
| RATING VOLTAGE | 60 V AC (R.M.S) |
| RATING FREQUENCY | DC~6 GHz |
| OPERATING TEMPERATURE | 233~363 K (-40°C~+90°C) |
| VSWR | 1.3 MAX. AT 0.1 ~ 3 GHz, 1.5 MAX. AT 3 ~ 6 GHz |
| MAIN CONTACT RESISTANCE | INITIAL: 20 mohm MAX. / AFTER TEST: Δ R 20 mohm MAX. |
| GROUND CONTACT RESISTANCE | INITIAL: 20 mohm MAX. / AFTER TEST: Δ R 20 mohm MAX. |
| INSULATION RESISTANCE | INITIAL: 500 Mohm MIN. / AFTER TEST: 100 Mohm MIN. |
| DIELECTRIC WITHSTANDING VOLTAGE | 200 V AC, 1 MINUTE |
| DURABILITY | 30 CYCLES |
| UNMATING FORCE (INITIAL / AFTER TEST) | INITIAL: 4 N MIN. / AFTER TEST: 2 N MIN. |
| CRIMP STRENGTH | 7 N MIN. |
| PRODUCT SPECIFICATION | PRS-2532 |
| TEST REPORT | TR-18089 |
| INSTRUCTION MANUAL | HIM-16014 |

Rev.2

MHF[®] 5 plug Ni top (0.81,0.64)

Recommended P/N 20711-001R-81

| PART NO. | APPLICABLE CABLE | OUTER CONDUCTOR |
|---------------|--------------------|-----------------------|
| 20711-001R-81 | AWG#36 (0.64 O.D.) | SPIRAL SHIELD |
| | AWG#36 (0.81 O.D.) | SINGLE BRAIDED SHIELD |

Offered as harness only.

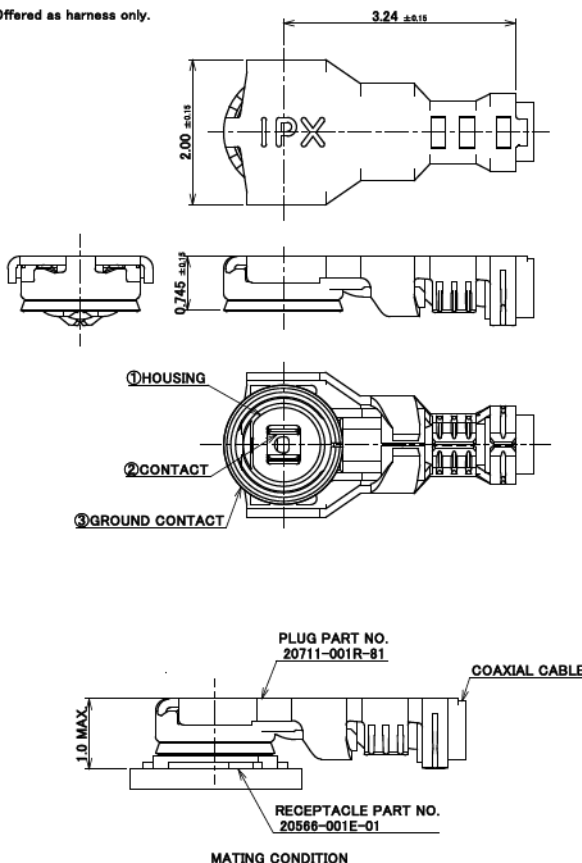

NOTES.

1. APPLICABLE CONNECTOR: 20566-001E-01
2. PERMISSIBLE LOAD OF CABLE AT MATING
3. MATING AND UNMATING INSTRUCTION

3-1. MATING

MATE THE CONNECTOR VERTICALLY AS MUCH AS POSSIBLE, ADJUSTING THE MATING AXIS OF PLUG AND RECEPTACLE. DO NOT SLANT MATE.

3-2. UNMATING

3-2-1. IN CASE OF UNMATING BY PULLING TOOL (PART NO. 90612-0001)

USE THE PULLING TOOL AS THE FOLLOWING DRAWING, AND PULL PLUG TO VERTICAL DIRECTION AS DIRECTLY AS POSSIBLE.

3-2-2. IN CASE OF UNMATING DIRECTLY BY HAND

CATCH THE CATCHING AREA OF PLUG, AND PULL PLUG TO VERTICAL DIRECTION AS DIRECTLY AS POSSIBLE.

NOTE 2.

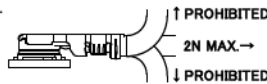

NOTE 3-1.

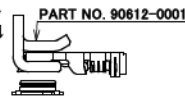

NOTE 3-2-1.

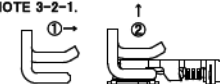

NOTE 3-2-2.

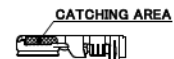

| NO. | DESCRIPTION | MATERIAL | FINISH, REMARKS |
|-----|----------------|-----------------|---|
| 3 | GROUND CONTACT | PHOSPHOR BRONZE | ALL OVER Ni 1.00 μ m MIN. CONTACT PART Au 0.02 μ m MIN. [Ni PLATING AREA] Ni ONLY |
| 2 | CONTACT | PHOSPHOR BRONZE | ALL OVER Ni 1.00 μ m MIN. CONTACT PART Au 0.03 μ m MIN. |
| 1 | HOUSING | LCP | UL94V-0, BLACK |

Rev.3

MHF[®] 5 plug Ni top (0.81,0.64)

| ITEMS | SPECIFICATION | |
|---|--|--------------------|
| APPLICABLE CABLE | AWG#36 (0.81 O.D.) *RECOMMENDED | AWG#36 (0.64 O.D.) |
| RECOMMENDED APPLICABLE CONNECTOR PART No. | 20566-001E-01 | |
| RATING VOLTAGE | 60 V AC (R.M.S) | |
| RATING FREQUENCY | DC~6 GHz | |
| OPERATING TEMPERATURE | 233~363 K (-40°C~+90°C) | |
| VSWR | 1.3 MAX. AT DC~3 GHz, 1.5 MAX. AT 3~6 GHz | |
| MAIN CONTACT RESISTANCE | INITIAL: 20 mohm MAX. / AFTER TEST: Δ R 20 mohm MAX. | |
| GROUND CONTACT RESISTANCE | INITIAL: 20 mohm MAX. / AFTER TEST: Δ R 100 mohm MAX. | |
| INSULATION RESISTANCE | INITIAL: 500 Mohm MIN. / AFTER TEST: 100 Mohm MIN. | |
| DIELECTRIC WITHSTANDING VOLTAGE | 200 V AC, 1 MINUTE | |
| DURABILITY | 30 CYCLES | |
| UNMATING FORCE (INITIAL / AFTER TEST) | INITIAL: 4 N MIN. / AFTER TEST: 2 N MIN. | |
| CRIMP STRENGTH | 7 N MIN. | |
| PRODUCT SPECIFICATION | PRS-2108 | PRS-2109 |
| TEST REPORT | TR-15062 | TR-15063 |
| INSTRUCTION MANUAL | HIM-16013 | |

Rev.3

MHF[®] 5 PLUG Ni top (0.48)

| Recommended P/N | 20615-002R-48 | | |
|-----------------|---------------|--------------------|-----------------|
| PART No. | PLATING | APPLICABLE CABLE | OUTER CONDUCTOR |
| 20615-001R-48 | ALL Au | AWG#38 (0.48 O.D.) | SPIRAL SHIELD |
| 20615-002R-48 | SELECTIVE Ni | | |

Offered as harness only.

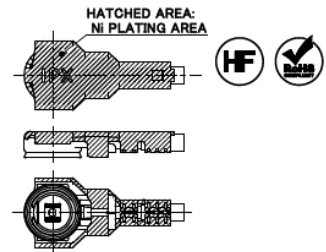
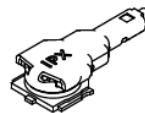
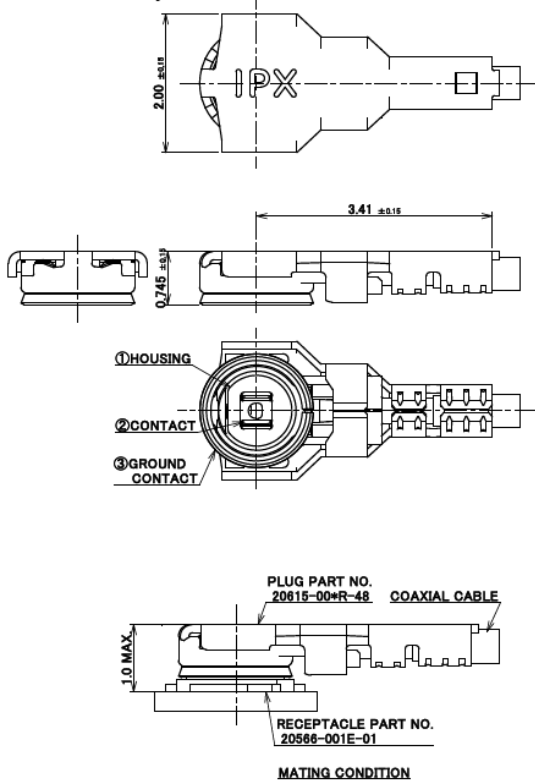

SELECTIVE NI TYPE (PART NO. 20615-002R-48)

NOTES

1. APPLICABLE CONNECTOR: 20566-001E-01
2. PERMISSIBLE LOAD OF CABLE AT MATING
3. MATING AND UNMATING INSTRUCTION

3-1. MATING

MATE THE CONNECTOR VERTICALLY AS MUCH AS POSSIBLE, ADJUSTING THE MATING AXIS OF PLUG AND RECEPTACLE. DO NOT SLANT MATE.

3-2. UNMATING

3-2-1. IN CASE OF UNMATING BY PULLING TOOL (PART NO. 90612-0001): USE THE PULLING TOOL AS THE FOLLOWING DRAWING, AND PULL PLUG TO VERTICAL DIRECTION AS DIRECTLY AS POSSIBLE.

3-2-2. IN CASE OF UNMATING DIRECTLY BY HAND: CATCH THE CATCHING AREA OF PLUG, AND PULL PLUG TO VERTICAL DIRECTION AS DIRECTLY AS POSSIBLE.

4. PRECAUTIONS FOR CABLE POSITION

THE PLUG SHALL NOT BE PLACED WITHIN 50 DEGREES ANGLE FROM CENTER OF THE SIGNAL CONTACT. TILT THE PLUG AT LEAST 50 DEGREES FROM THE CENTER OF A SIGNAL CONTACT.

NOTE 2.



NOTE 3-1.

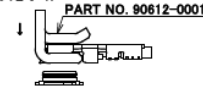

NOTE 3-2-1.

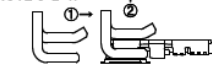

NOTE 3-2-2.

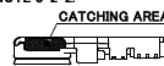

NOTE 4. ALLOWED

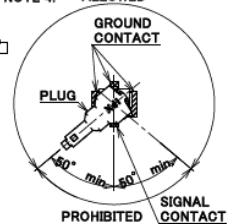

| | | | |
|-----|----------------|-----------------|--|
| 3 | GROUND CONTACT | PHOSPHOR BRONZE | ALL OVER Ni 1.00 μm MIN. CONTACT PART Au 0.05 μm MIN. |
| 2 | CONTACT | PHOSPHOR BRONZE | ALL OVER Ni 1.00 μm MIN. CONTACT PART Au 0.05 μm MIN. |
| 1 | HOUSING | LCP | UL94V-0, BLACK |
| NO. | DESCRIPTION | MATERIAL | FINISH, REMARKS |

Rev.4

MHF[®] 5 PLUG Ni top (0.48)

| ITEMS | SPECIFICATION | |
|---|---|--|
| | 20615-001R-48 (ALL Au PLATING TYPE) | 20615-002R-48 (SELECTIVE Ni PLATING TYPE) |
| PLUG PART No. | | |
| RECOMMENDED APPLICABLE CONNECTOR PART No. | 20566-001E-01 | |
| RATING VOLTAGE | 60 V AC (R.M.S) | |
| RATING FREQUENCY | DC ~ 6 GHz | |
| OPERATING TEMPERATURE | 233 ~ 363 K (-40°C ~ +90°C) | |
| VSWR | 1.3 MAX. AT 0.1 ~ 3 GHz, 1.5 MAX. AT 3 ~ 6 GHz | |
| MAIN CONTACT RESISTANCE | INITIAL: 20 mohm MAX. / AFTER TEST: Δ R 20 mohm MAX. | |
| GROUND CONTACT RESISTANCE | INITIAL: 20 mohm MAX. / AFTER TEST: Δ R 20 mohm MAX. | |
| INSULATION RESISTANCE | INITIAL: 500 Mohm MIN. / AFTER TEST: 100 Mohm MIN. | |
| DIELECTRIC WITHSTANDING VOLTAGE | 200 V AC, 1 MINUTE | |
| DURABILITY | 30 CYCLES | |
| UNMATING FORCE (INITIAL / AFTER TEST) | INITIAL: 4 N MIN. / AFTER TEST: 2 N MIN. | |
| CRIMP STRENGTH | 7 N MIN. | |
| PRODUCT SPECIFICATION | PRS-1939 | PRS-2032 |
| TEST REPORT | TR-14026 | TR-15029 |
| INSTRUCTION MANUAL | HIM-13003 | |

Rev.4

MHF[®] 5 PLUG Ni top



MHF 5 SMA ADAPTOR
PART NO. 90543-0001

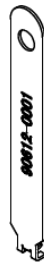

FRONT SIDE



BACK SIDE

MHF 5 PUSHING AND PULLING TOOL
PART NO. 90612-0001



MHF 5 PUSHING TOOL
PART NO. 90624-0001

Rev.3

MHF® 5 Receptacle

Recommended P/N 20566-001E-01

PART NO.
20566-001E-01

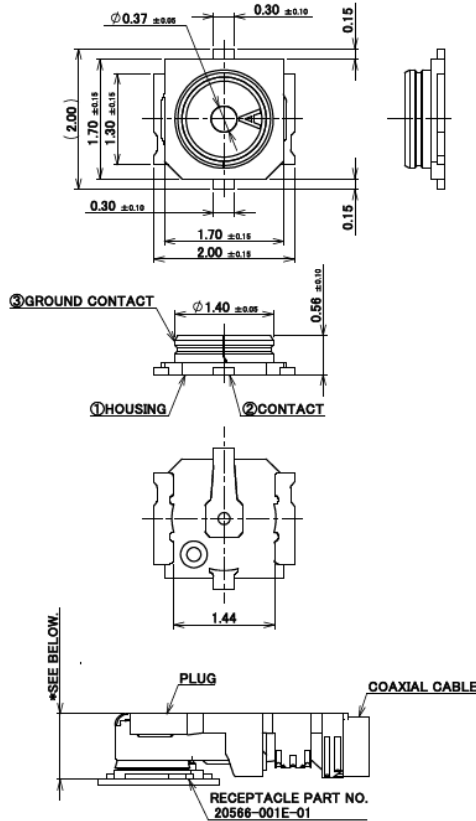

* 1.3 MAX. AT 20688-001R-13, 20714-001R-81
* 1.0 MAX. AT 20711-001R-81

MATING CONDITION

NOTES

1. APPLICABLE CONNECTOR

20567-001R-81
20615-004R-48
20688-001R-13
20689-001R-81
20711-001R-81
20714-001R-81

2. COPLANARITY: 0.1mm MAX.

3. THIS IS "Pb-FREE" CONNECTOR.

4. PRECAUTIONS FOR CABLE POSITION

[PART NO. 20567-001R-81, 20615-004R-48]

THE PLUG SHALL NOT BE PLACED WITHIN 50 DEGREES ANGLE FROM CENTER OF THE SIGNAL CONTACT.
TILT THE PLUG AT LEAST 50 DEGREES FROM THE CENTER OF A SIGNAL CONTACT.

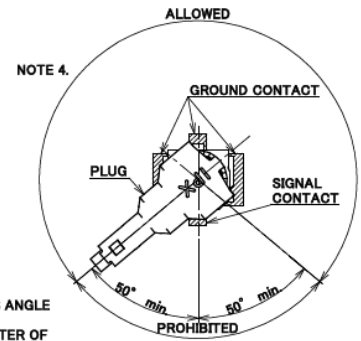

| NO. | DESCRIPTION | MATERIAL | FINISH, REMARKS |
|-----|----------------|-----------------|---|
| 3 | GROUND CONTACT | PHOSPHOR BRONZE | ALL OVER Ni 1.00 μ m MIN. CONTACT PART Au 0.01 μ m MIN. UNDER PLATE Pd-Ni 0.02 μ m MIN. SOLDERING PART Au 0.01 μ m MIN. UNDER PLATE Pd-Ni 0.02 μ m MIN. |
| 2 | CONTACT | BRASS | ALL OVER Ni 1.00 μ m MIN. CONTACT PART Au 0.1 μ m MIN. SOLDERING PART Au 0.03 μ m MIN. |
| 1 | HOUSING | LCP | UL94V-0, BLACK |

Rev.6

MHF® 5 Receptacle

| ITEMS | SPECIFICATION | | |
|---|---|---|---|
| RECOMMENDED APPLICABLE CONNECTOR PART No. | 20688-001R-13 | 20711-001R-81 (CABLE AWG#36 ϕ 0.81) | 20714-001R-81 |
| RATING VOLTAGE | 60 V AC (R.M.S) | | |
| RATING FREQUENCY | DC~12 GHz | | |
| OPERATING TEMPERATURE | 233~363 K (-40°C~+90°C) | | |
| VSWR | 1.3 MAX. AT DC~3 GHz, 1.4 MAX. AT 3~6 GHz, 1.5 MAX. AT 6~12 GHz | | |
| MAIN CONTACT RESISTANCE | INITIAL: 20 mohm MAX. / AFTER TEST: Δ R 20 mohm MAX. | | |
| GROUND CONTACT RESISTANCE | INITIAL: 20 mohm MAX. / AFTER TEST: Δ R 100 mohm MAX. | | |
| INSULATION RESISTANCE | INITIAL: 500 Mohm MIN. / AFTER TEST: 100 Mohm MIN. | | |
| DIELECTRIC WITHSTANDING VOLTAGE | 200 V AC, 1 MINUTE | | |
| DURABILITY | 30 CYCLES | | |
| UNMATING FORCE (INITIAL / AFTER TEST) | INITIAL: 5 N MIN. AFTER TEST: 3 N MIN. | INITIAL: 4 N MIN. AFTER TEST: 2 N MIN. | INITIAL: 5 N MIN. AFTER TEST: 3 N MIN. |
| PRODUCT SPECIFICATION | PRS-2192 | PRS-2108 | PRS-2236 |
| TEST REPORT | TR-16003 | TR-15062 | TR-16049 |
| PACKING STANDARD | PST-12036 | | |
| INSTRUCTION MANUAL | HIM-16014 | HIM-16013 | HIM-16014 |

Rev.6

MHF[®] 5 Receptacle

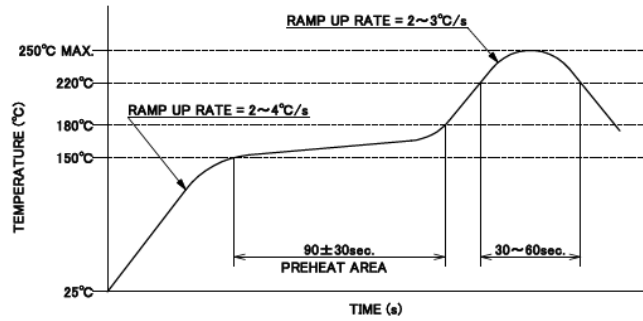
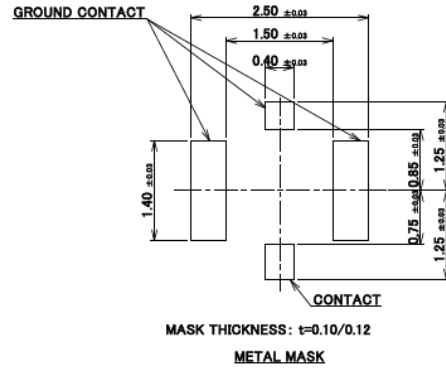
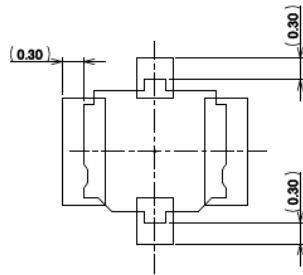
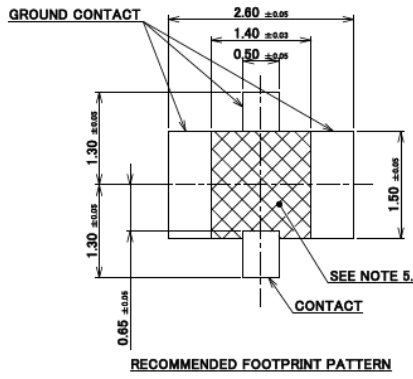

NOTES.
5. CUT OUT PROHIBITION AREA

Rev.6

Accessories for MHF[®] 5 Receptacle



SMA ADAPTOR FOR MHF 5 PLUG
PART NO. 90543-0001



MHF 5 HIGH CYCLE PROBE
PART NO. 90690-0001

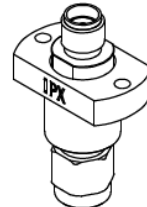

MHF 5 HIGH CYC ADAP BASE UNIT
PART NO. 90684-0001

* 90690-0001 AND 90684-0001 SHOULD BE USED TOGETHER.

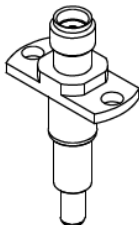

MHF 5 HIGH CYCLE ADAPTOR
PART NO. 90793-0001

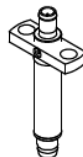

MHF 5 4.5MM HIGH CYCLE TEST PROBE LONG TYPE
PART NO. 90847-0001

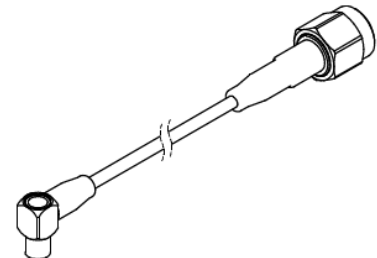

4.5MM HIGH CYCLE TEST PROBE CABLE ASS'Y
PART NO. 90577-****

* 90847-0001 AND 90577-**** SHOULD BE USED TOGETHER.

Rev.6



Copyright © I-PEX Inc. 2020. All rights reserved.

I-PEX, MHF, CABLINE, NOVASTACK, EVAFLEX, MINIFLEX, ISH, IARPB, IASLP, ESTORQ, i-Fit and ISFIT are registered trademarks of I-PEX Inc. Please note that the contents in the catalog might be changed without prior notification. I-PEX Inc. assumes no responsibility for any inaccuracies or obligation to update Information on these documents. Please be sure to read and understand the latest "Precautions for Use" and "Instruction Manual" before you use our products. We shall not be responsible for any defects, damages or troubles in case you use our products without following the precautions for use. Please feel free to contact our sales representatives when you use our products for any applications that require very high reliability and safety, or that relate to human life (ex. nuclear power control, aerospace, transportation, medical equipment, safety equipment etc.).

Contact your sales representative for more detailed information. [i-pex.com]